

Dokumentation

HiPath 500, HiPath 2000, HiPath 3000, HiPath 5000
HiPath 4000, HiPath OpenOffice ME

OpenStage 40

OpenStage 40 T

Kurzbedienungsanleitung



Communication for the open minded

Siemens Enterprise Communications
www.siemens-enterprise.de

SIEMENS

Bedienung Ihres Telefons

Funktions- und Audiotasten

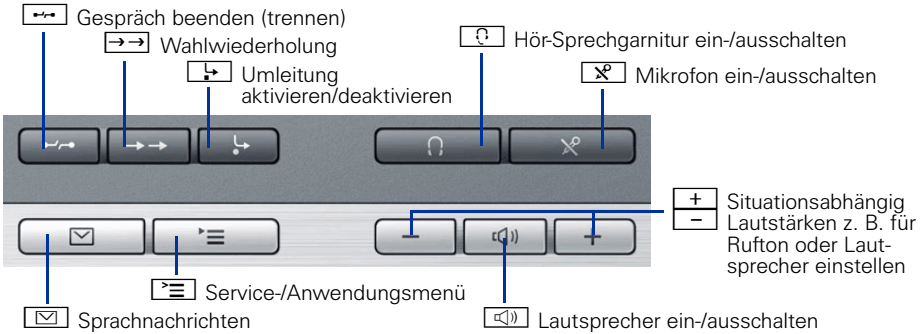

5-Wege Navigator

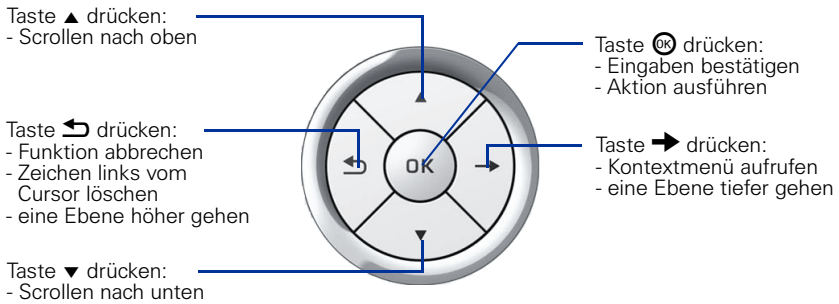

Frei programmierbare Sensortasten am Display

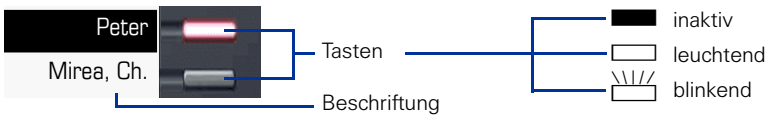

Display

Elemente

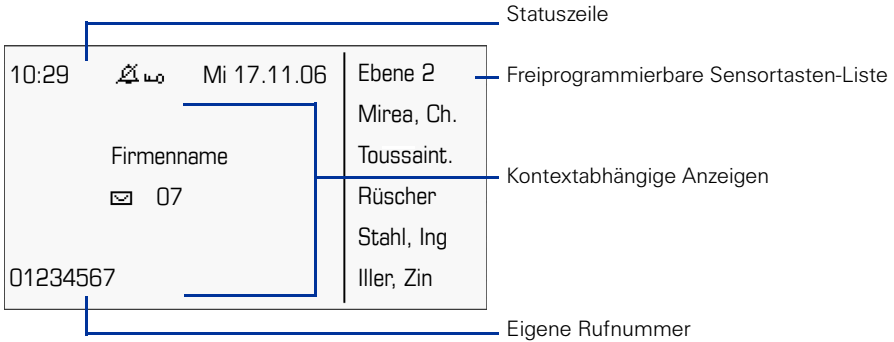



Rufnummern- und Texteingabe

Wähltastatur

In Situationen, in denen eine Texteingabe möglich ist, können Sie mit den Wähltasten auch Text, Interpunktions- und Sonderzeichen eingeben. Drücken Sie dazu die Zifferntasten mehrfach.

Zusatzfunktionen bei Asterisk- und Rautetaste:

Taste	Funktion bei Texteingabe	Funktion bei Langdruck
	Sonderzeichen schreiben.	Rufton ausschalten.
	Zwischen Groß- / Kleinschreibung und Zifferneingabe umschalten.	Telefonsperrung aktivieren.

Wichtige Bedienprozeduren

	Hörer abheben		Text- oder Nummer eingeben
	Hörer auflegen		Eintrag auswählen
	Gespräch führen		Kontextmenü öffnen
	Rufsignal/Anklopftton		Nächster Bedienschritt

HiPath 4000 Im Ruhezustand



Anruf über Hörer annehmen



Anruf über Freisprechen annehmen













Aus Anruferliste wählen

- ➔ ▷ ◆ „Unbeantwortete Anrufe?“; „Kommende Anrufe?“ oder „Gehende Anrufe?“ 
- ▷ ◆ Anruf auswählen  ▷ ◆ „Ausgeben?“ 

Rückruf aktivieren

-  Zielrufnummer  ▷ bei nichtmelden oder besetzt: ◆ „Rückruf?“ 



Rufnummer auf Taste speichern

- Programmierbare Taste lange drücken ▷ „Ändern?“  ▷ ◆ „Zielwahl?“ 
- ▷ „Speichern?“  ▷  ▷ „Ziele?“ ▷ ◆ „Zielwahl?“ 
- ▷ ■ Programmierbare Taste drücken ▷ „Neue Nummer eingeben?“ 
- ▷  Rufnummer ▷ „Fertig?“  ▷ „Rufnummer übernehmen?“  ▷ „Speichern?“ 

Mit gespeicherter Nummer wählen

- gespeicherte Rufnummer ▷  Lautsprecher schaltet sich automatisch ein oder 







Funktion auf Taste speichern

- ▣ Programmierbare Taste lange drücken ▷ ⬇ „Ändern?“ 
- ▷ ⬆ gewünschte Funktion auswählen  ▷ ⬇ „Speichern?“ 

Wahl wiederholen



Anrufumleitung programmieren

-  ▷ „Ziele?“  ▷ „Umleitung?“  ▷ „Näch. Umleitungstyp?“ 
- ▷ wiederholen, bis zum gewünschten Umleitungstyp („Variable Umleitung“, „Feste Umleitung“, „Uml. für intern“, „Uml. für extern“, „Umleitung besetzt“, „Umleitung nach Zeit“ oder „Uml. besetzt/n. Zeit“) ▷ ⬇ „Ziel eingeben?“ 
- ▷  Rufnummer ▷ „Speichern?“ 

Anrufumleitung (Feste Umleitung) für alle Anrufe ein-/ausschalten



Während eines Gesprächs mit einem Teilnehmer A

Auf Freisprechen umschalten

 gedrückt halten ▷  (nur USA:  ▷ 





Rückfrage

◆ ▷ „Rückfrage?“  ▷  Rufnummer Teilnehmer B ▷  Teilnehmer B
 ▷ ◆ „Beenden und zurück?“  ▷  Teilnehmer A





Anklopfen annehmen

 Anklopfton ▷ ◆ „Anklopfer übernehmen?“  ▷  Teilnehmer B
 ▷ ◆ „Beenden und zurück?“  ▷  Teilnehmer A

Konferenz einleiten

◆ „Rückfrage?“  ▷  Rufnummer Teilnehmer B ▷  Teilnehmer B
 ▷ ◆ „Konferenz?“  ▷  Teilnehmer A und B

Konferenz bei Anklopfen einleiten

 Anklopfton ▷ ◆ „Anklopfer übernehmen?“  ▷  Teilnehmer B
 ▷ ◆ „Konferenz?“  ▷  Teilnehmer A und B

Gespräch ohne Rückfrage übergeben

◆ „Rückfrage?“  ▷  Zielrufnummer ▷ 

Gespräch nach Rückfrage übergeben

◆ „Rückfrage?“  ▷  Rufnummer Teilnehmer B ▷  Teilnehmer B ▷ 

HiPath 500/2000/3000/5000, HiPath OpenOffice ME

Im Ruhezustand

Anruf über Hörer annehmen



Anruf über Freisprechen annehmen











Anruf abweisen





Rückruf aktivieren

 Zielrufnummer  ▷ bei nichtmelden oder besetzt:  „Rückruf?“ 









Rufnummer auf Taste speichern

 Programmierbare Taste lang drücken ▷  „Taste ändern“  ▷  „Ziele“ 
▷   „Rufnummer“  ▷  Rufnummer ▷ „speichern“  ▷ „beenden“ 







Mit gespeicherter Nummer wählen

 gespeicherte Rufnummer ▷  Lautsprecher schaltet sich automatisch ein oder 







Funktion auf Taste speichern

 Programmierbare Taste lang drücken ▷  „Taste ändern“ 
▷   gewünschte Funktion auswählen  ▷   „beenden“ 

Wahl wiederholen

 ▷ eventuell gewählte Nummer suchen:  „blättern“  ▷   „anrufen“  ▷ 

Anrufumleitung programmieren

 ▷  gewünschten Umleitungstyp auswählen („1=alle Anrufe“, „2=nur externe Anrufe“, „3=nur interne Anrufe“)  ▷  Rufnummer
▷   „speichern“ 

Während eines Gesprächs mit einem Teilnehmer A

Auf Freisprechen umschalten

 gedrückt halten ▷  (nur USA:  ▷ )

Rückfrage

◆ ▷ „Rückfrage“  ▷  Rufnummer Teilnehmer B ▷  Teilnehmer B
▷ „beenden und zurück“  ▷  Teilnehmer A

Konferenz einleiten

◆ „Konferenz einleiten“ oder „Rückfrage“  ▷  Rufnummer Teilnehmer B
▷  Teilnehmer B ▷ ◆ „Konferenz“  ▷  Teilnehmer A und B

Gespräch ohne Rückfrage übergeben

◆ „Rückfrage“  ▷  Zielrufnummer ▷ 

Gespräch nach Rückfrage übergeben

◆ „Rückfrage“  ▷  Rufnummer Teilnehmer B ▷  Teilnehmer B ▷ 

Communication for the open minded

Siemens Enterprise Communications
www.siemens-enterprise.de

Copyright © Siemens Enterprise
Communications GmbH & Co. KG
Hofmannstr. 51
80200 München
Deutschland

Siemens Enterprise
Communications GmbH & Co. KG
is a Trademark Licensee of Siemens AG

Sachnummer:
A31003-S2000-U115-5-19

Die Informationen in diesem Dokument enthalten lediglich allgemeine Beschreibungen bzw. Leistungsmerkmale, welche im konkreten Anwendungsfall nicht immer in der beschriebenen Form zutreffen bzw. welche sich durch Weiterentwicklung der Produkte ändern können. Die gewünschten Leistungsmerkmale sind nur dann verbindlich, wenn sie bei Vertragsschluss ausdrücklich vereinbart werden. Liefermöglichkeiten und technische Änderungen vorbehalten. OpenScape, OpenStage und HiPath sind eingetragene Warenzeichen der Siemens Enterprise Communications GmbH & Co. KG. Alle anderen Marken-, Produkt- und Service-namen sind Warenzeichen oder eingetragene Warenzeichen ihrer jeweiligen Inhaber.